



XRIDER[®]
Passion from the universe

CX3 AIR

1/10 RC MOTORCYCLE

Manual

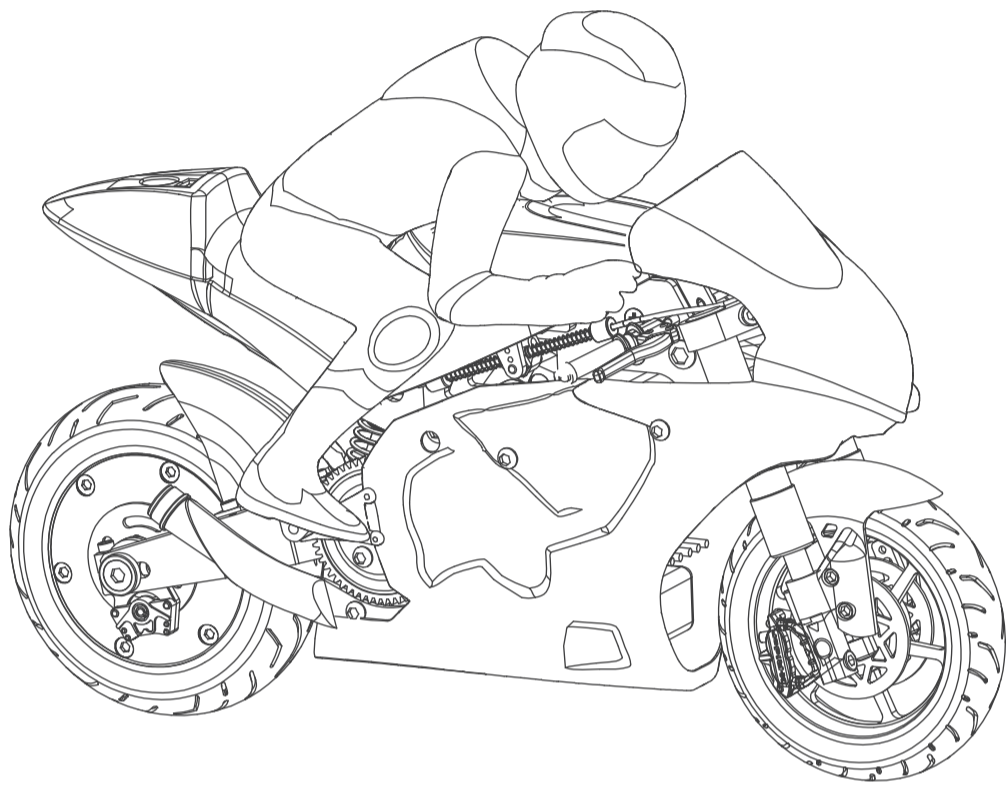

04 Illustration of Main Parts

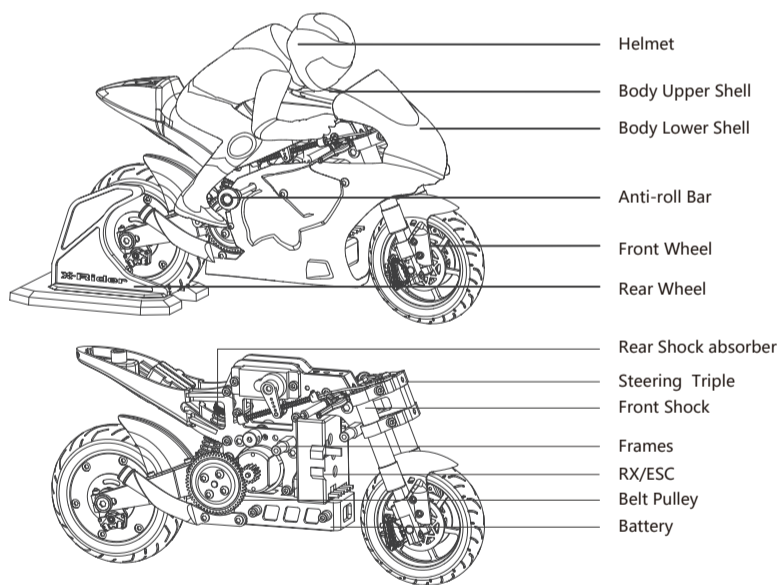

05 Ready To Run Preparation

1. Check all the parts in the box.

When you open the box, you will find follow parts:

Motorcycle	Remote Control	Bike Stand	Rider	Accessories	Manual	Sticker	Battery Charger
1set	1set	1pc	1set	1package	2pcs	2pcs	1pc

Equipment Sold Separately: 4-Cell AAA Battery ,Silicone Oil, Screw Glue, Tire Rubber.
Tool Required: Hex screwdriver,Cross Wrench,Cross Screwdrive,Tweezers,Hex Wrench.

2. Remove the R-Clip and the body shell.

3. Connect the battery with the RX/ESC.

Caution: When connect the battery with the RX/ESC, please keep the RX/ESC in off state.

4. Install rider , body and anti-roll bars.

Install the rider on the body , then install the body on the main frame,fix the body post with the R-clip or screw.
Install the anti-roll bar and put it set into the anti-roll bar post then lock each of the grains.

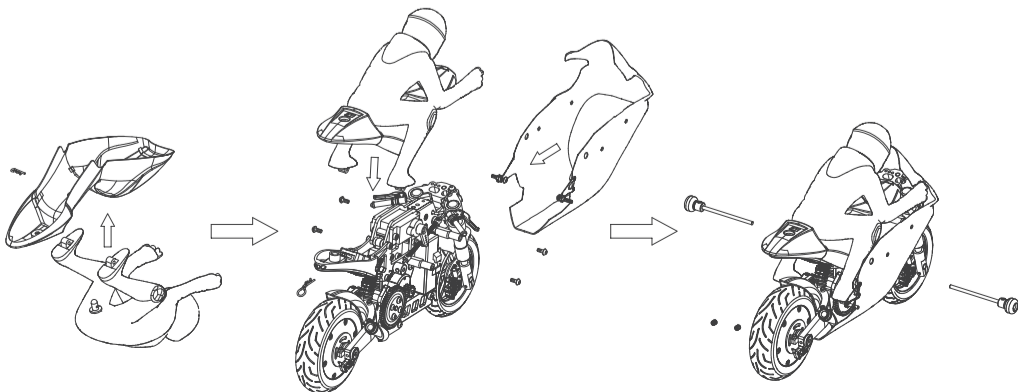

01 Product Description

Thank you for purchasing X-RIDER CX3-AIR. We believe that this new motorcycle will bring you infinite happiness. Before use, please read the manual carefully and safe keeping. Accidents are caused by illegal use, the company doesn't undertake any responsibility.

The CX3-AIR is a sport RC motorcycle.This product has as below features:

- Innovative design of the front wheel inverted shock absorbers and rear wheel pendulum arm suspension for the most reliable grip performance.
- Belt drive could realize a lower power depreciation
- Built-in a mechanical gyro in the rear wheel, providing an easy platform to control and amore stable driving experience
- New design is lightweight and easy maintenance.

In order to exert the performance, for maximum enjoyment of this product,please read this manual carefully. We will have strict testing and debugging before exiting the facility. We promise to customers. Products issue without any material and process problems. We will free for customers to repair within 90 days from the date of purchase. Customer service e-mail: service@cx3rider.com. The warranty doesn't cover crash damage,modification,failure to maintenance, or the damaged caused by improper use.

The warranty doesn't cover any result which caused by the final user's assembly or the material used for final user's assembly

02 Safety Precautions

1. The specification of the logo

⚠ Caution: this symbol indicates where caution is essential to avoid injury to yourself or others.

📌 Note: this symbol indicates where give you a tip in use

2. The safety of Children

- This model is not a toy. It is designed for users over 14 years of age.
- As the product includes small and sharp parts, assemble and store this product only in places out of the reach of children.

3. The safety of User

- It's highly recommended that first-time enthusiasts seek the advice of an experienced modeler before operating this vehicle.
- Cutters,wire cutter and screwdrivers need careful handling.
- Do not touch moving gears. They can cause injury.
- During and after operation,the motor and batteries will be hot. Do not touch them until they have had time to cool down.

4. The safety of User

- It's highly recommended that first-time enthusiasts seek the advice of an experienced modeler before operating this vehicle.
- Cutters,wire cutter and screwdrivers need careful handling.
- Do not touch moving gears. They can cause injury.
- During and after operation,the motor and batteries will be hot. Do not touch them until they have had time to cool down.

5. The range of use

- It can run your car on Asphalt land , on floor, in sandy,on short carpet Etc .
- Do not operate the model on public roads, in crowded places or near infants. It may cause accidents or injury.
- This product emits electrical waves so do not operate: Inside an aircraft. Near automatic devices such as automatic doors and fire alarms. Inside hospitals or medical equipment. Operating may cause accidents.

6. The maintenance of product

- Do not store this model in a high-temperature/humidity area or in direct sunlight.
- Do not use water,alcohol, or thinner to clean your car's body.
- Simply wipe it down with a clean, soft cloth.

03 The size of Product

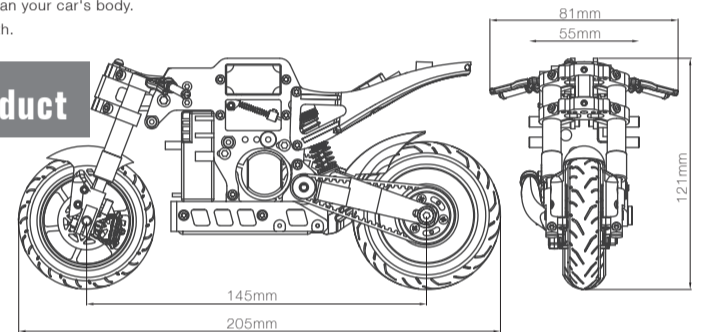

06 Steering Setup

Basic Controls:

Caution : RC Motorcycle comes with a Counter-Steering System. It means the direction between the transmitter steering wheel and the motorcycle front wheel are opposite.

Please setting AUX of the remote control when power on.(Refer to the manual of the remote control .)

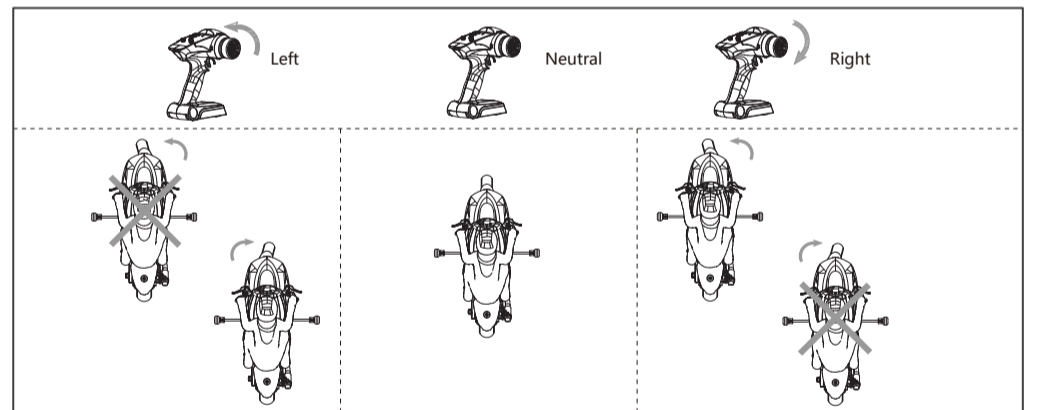

To return the motorcycle from a leaning posture to and upright posture,turn the steering in the opposite direction to the lean.

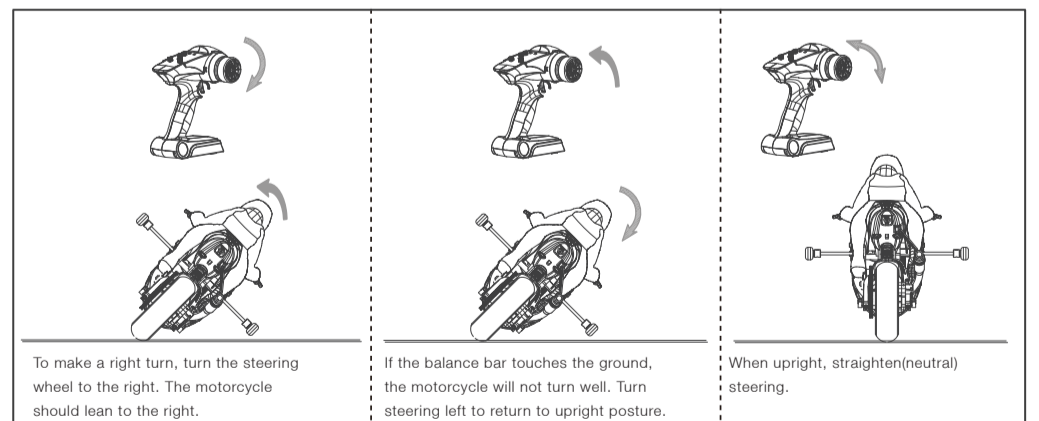

07 Cornering Tips

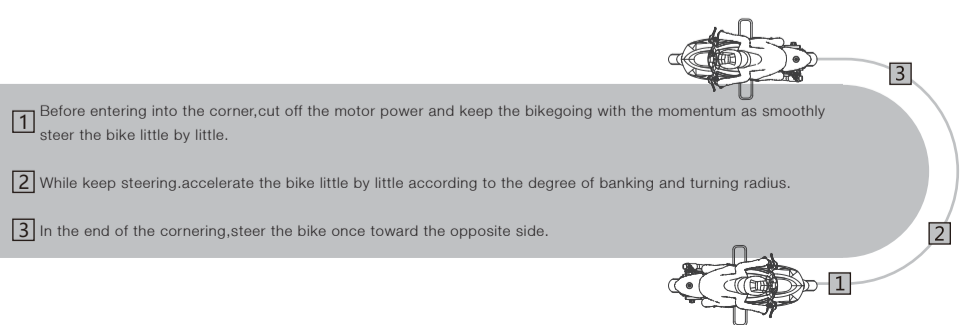

- 1 Before entering into the corner,cut off the motor power and keep the bikegoing with the momentum as smoothly steer the bike little by little.
- 2 While keep steering,accelerate the bike little by little according to the degree of banking and turning radius.
- 3 In the end of the cornering,steer the bike once toward the opposite side.

08 Installation Instructions

01

Note: Please secure the rim and the tire with tire rubber after finishing assembly.

02

Note: Apply gear silicone oil#10000 on the shaft and the spring.

03

Note: Please coated the screw glue first when screwing down the flat head screw(M2x6) . Please grease the planet gear first when install the gyro pocket. Pls apply the rim and the tire with CA glue after finishing assembly. When change the tire , please check the bearing have any injured and apply the gear silicone oil.

04

05

06

07

08

09

Note: The user could adjust the effect of the rear suspension according to different racing ground by installing shock body spacer.

10

11

Note: Do not too tight or loose at the belt.

12

13

14

15

16

09 Drawing No. and Name in Assembling

Ref. No	Part Name	PCS
XR-A1028	Handle Set	1set
XR-A1029	Anti-roll Bar Set	1set
XR-A1044	Anti-roll Bar Post	2pcs
XR-A2001	Steering Triples	2pcs
XR-A2007	Fr. Brake Disc	2pcs
XR-A2012	Shock Absorber	1pc
XR-A2017	Rear Brake Disc	1pc
XR-A3005	Tires(50")	1set
XR-A3008	Fr. Caliper Brake set	1set
XR-A3014	Belt Drive	1pc
XR-A3015	Belt Pulley Set	1set
XR-A3019P	Gyro Shaft	1pc
XR-A3031	Bike Stand	1pc
XR-A2022H	Servo	1pc
XR-A1038	R-Clip	10pcs
XR-A3001	Fr. Shock Absorber	1pc
XR-A3002	Steering Support	1set

Ref. No	Part Name	PCS
XR-A3003	Steering Shaft	1pc
XR-A3004	Front Rim	1pc
XR-A3006	Fr. Wheel Shaft	1pc
XR-A3007	Front Fender	1pc
XR-A3009	Steering Linkage Set	1set
XR-A3010	Front Frame	1set
XR-A3011	Frame Post	1set
XR-A3012	Body Post	4pcs
XR-A3013	Rear Frame	1set
XR-A3016	132 Brushed Motor	1pc
XR-A3017	Motor holder	1pc
XR-A3020	55T Spur Gear	1pc
XR-A3022	14T Motor Gear	1pc
XR-A3023	Battery Cover	1pc
XR-A3024	Exhaust Pipe	1pc
XR-A3025	Battery 7.4V/25C/550mAh	1pc
XR-A3027	Rear Swing Arm Shaft	1pc

Ref. No	Part Name	PCS
XR-A3028	Rear Swing Arm	1set
XR-A3029	Gyro Cover	1set
XR-A3030	Gyro Flywheel	1pc
XR-A3032	Gyro Clutch	1pc
XR-A3034	Gyro Gear Cover	1pc
XR-A3035	Gyro Planet Gear	3pcs
XR-A3036	Gyro Inner Gear	1pc
XR-A3037	Gyro	1pc
XR-A3039	Rear Wheel	1pc
XR-A3041	Rear Fender	1pc
XR-A3042	Body	1set
XR-A3043	Rider	1pc
XR-A3044	USB Charger	1pc
XR-A3045	Remote Control	1set
XR-A3045RX	RX/ESC	1pc
XR-A3046	Rear Caliper Brake Set	1pc

XRIDER
Passion From the universe

X-RIDER MODEL COMPANY LIMITED
www.cx3rider.com
Unit 11, 27/F., K. Wah Centre, 191 Java Road, North Point, Hong Kong
Email: Info@cx3rider.com
©Copyright 2020 X-RIDER